



GigE Vision

VGA Monochrome CCD Camera

FV-G030B1

User's Guide

**RICOH COMPANY, LTD.**

## Table of Contents

<b>1</b>	<b>Connector Specifications</b>	<b>3</b>
1.1	RJ45 Connector	3
1.2	DC Iris Lens Connector	4
1.3	Power-I/O Connector	4
1.3.1	Equivalent Circuit for the Input Pin of the I/O Connector	6
<b>2</b>	<b>Camera Output Timing Charts</b>	<b>7</b>
2.1	Horizontal Timing	7
2.2	Vertical Timing	7
2.2.1	Full Scanning	7
2.2.2	AOI (Area of Interest)	8
2.3	Pixel Transferring Image	9
<b>3</b>	<b>Camera Operational Modes</b>	<b>10</b>
3.1	Normal Mode	10
3.2	Pulse Width Trigger Mode	10
3.2.1	Timing	10
3.2.2	Exposure Timing with the Positive Polarity Trigger Signal	11
3.2.3	Exposure Timing with the Negative Polarity Trigger Signal	11
3.3	Edge Preset Trigger Mode	12
3.3.1	Timing	12
3.3.2	Exposure Timing with the Positive Polarity Trigger Signal	13
3.3.3	Exposure Timing with the Negative Polarity Trigger Signal	13
3.4	Edge Preset Trigger Mode (Trigger Input While the Image Is Out)	14
3.4.1	Timing	14
3.4.2	Exposure Timing with the Positive Polarity Trigger Signal	15
3.4.3	Exposure Timing with the Negative Polarity Trigger Signal	15
3.5	H Reset Mode	16
<b>4</b>	<b>Communication Protocol</b>	<b>17</b>
4.1	Communication Method	17
4.2	Communication Settings	17
4.3	Communication Format	17
4.4	Camera Control Command	20
4.4.1	Camera Command List (Device Code: 000000)	20
4.4.2	Camera Command List (Device Code: 100000)	22
4.4.3	Descriptions of the Camera Control Commands (Device code: 000000);	24
4.4.4	Descriptions of the Camera Commands (Device code: 100000);	30
4.5	GenICam Command / Camera Command Reference Table	34

## 1 Connector Specifications

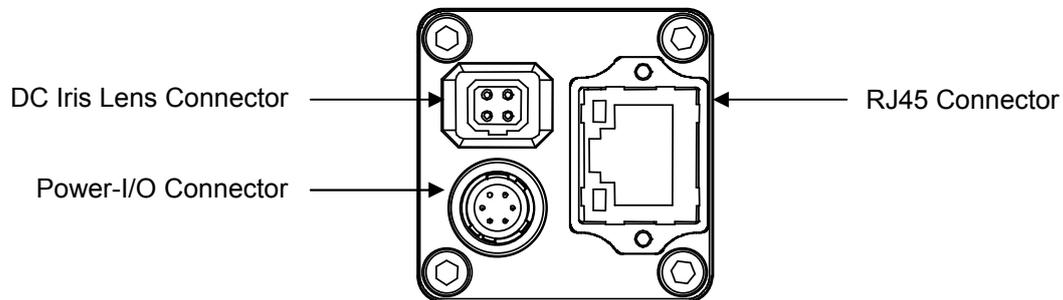

### 1.1 RJ45 Connector

**This product is NOT a PoE type. Apply power (+10.8 to +26.4Vdc) ONLY through the I/O connector.**

#### Pin Assignment:

Pin No.	Signal Name
1	TA+
2	TA-
3	TB+
4	TC+
5	TC-
6	TB-
7	TD+
8	TD-

#### LED Information:

Green LED	Yellow LED	Status
Green Light ON	Orange Light ON	Power ON
Green Light ON	Orange Light Blinking	1Gb Transferring
Light OFF	Orange Light Blinking	100 Mb Transferring

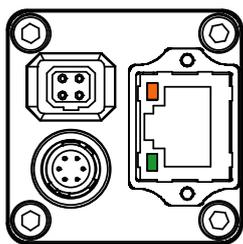

The camera is powered-on

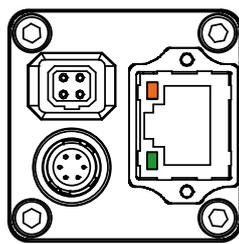

Green light: ON  
Yellow light: Blinking  
1 Gb Transferring

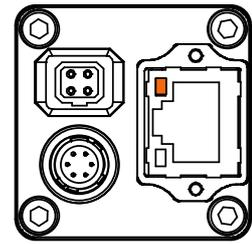

Green light: OFF  
Yellow light: Blinking  
100 Mb Transferring

**Please use a 1Gb supported NIC, HUB and LAN cable. Check that the NIC and HUB being used is “1Gb transferring”.**

**Damaging or mishandling the CAT5e cable may cause the transferring speed to change from 1Gb to 100Mb. If this happens, please replace the CAT5e cable.**

## 1.2 DC Iris Lens Connector

- M1951 (EMUDEN) or equivalent.

### Pin Assignment

Pin No.	Signal Name
1	DAMP-
2	DAMP+
3	DRIVE+
4	DRIVE-

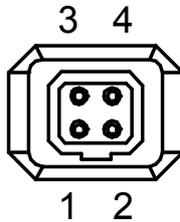

## 1.3 Power-I/O Connector

- HR10A-7R-6PB (Hirose) or equivalent
- This connector is for the power supply (12Vdc) and input /output signals.
- Use HR10A-7P-6S (Hirose) or equivalent for the cable side.

### Pin Assignment

Pin No.	Signal Name	IN / OUT	Voltage
1	GND	IN	0V
2	I/O-1	OUT	+3.3V LVTTTL
3	I/O-2	OUT	+3.3V LVTTTL
4	TRG_In-	IN	Smaller than 1.0V (Opt. Isolated -)
5	TRG_In+	IN	+3.0 to +26.4V (Opt. Isolated +)
6	POWER IN	IN	+10.8 to +26.4 Vdc

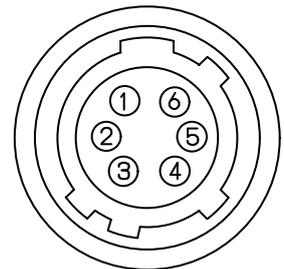

- Output signals can be assigned through the camera setting communication.  
(Device Code = 00H, Command = F0H and F1H)

### IO Signal Patterns for Pin No.2 (I/O-1) and Pin No.3 (I/O-2)

Command No.				HR10A-7R-6PB (Hirose)
F0H[3..0]	F1[3]	F0H[7..4]	F1[4]	I/O-1 (Pin No.2) / I/O-2 (Pin No.3)
For I/O-1 (Pin No. 2)		For I/O-2 (Pin No.3)		
0H (initial setting)	-	0H	-	FrameTriggerWait (initial setting for I/O-1)
1H	Set Value	1H	Set Value	UserOutput
2H	-	2H (initial setting)	-	ExposureActive (initial setting for I/O-2)
3H	-	3H	-	TriggerAuxiliary
4H	-	4H	-	TriggerInternal
5H	-	5H	-	SensorReadOut
6H	-	6H	-	StrobeSignal
7H-FH	-	7H-FH	-	For Test Use Only

Note: I/O-1 can be assigned only by F0H[3..0] and F1[3], and I/O-2 can be assigned only by F0H[7..4] and F1[4].

## 1) FrameTriggerWait

The user can check the camera condition (camera exposure and image output processing by the trigger signal with this FrameTriggerWait signal).

This signal is LOW for the period from the trigger input signal to the image output.

- a) High status (3.3V): No processing by the trigger signal. The camera accepts the trigger signal.
- b) Low status (0V): The camera is exposed and the image output processes by the trigger signal.

The camera default setting is the input trigger signal is INVALID while at the low status of this signal. When the exposure starts while the image output by the next trigger signal, please change the camera setting (Device code: 00H, Command No. :13H) to accept the trigger signal while the image outputs.

The noise appears on the image when the exposure begins while the image is output. The noise appears on the image when the start exposure while the image is output. In this case, please change the "H reset" for the exposure start mode (Device code: 00H, Command No. : 12H) to change the exposure start point to the next HD timing.

## 2) UserOutput

The status of the UserOutput signal can change with the "UserOutputValue".

- a) High status (3.3V)
- b) Low status (0V).

## 3) ExposureActive

The user can check the exposure time with the ExposureActive signal.

- a) High status (3.3V): The camera is exposing
- b) Low status (0V): The camera is not exposed

## 4) TriggerAuxiliary

The TriggerAuxiliary signal is the input trigger signal.

## 5) TriggerInternal

The TriggerInternal signal is the input trigger signal with the trigger delay time.

## 6) SensorReadOut

The SensorReadOut signal is the FVAL signal, which is the image output period of the time.

## 7) StrobeSignal

The StrobeSignal signal is the strobe control signal.

## 1.3.1 Equivalent Circuit for the Input Pin of the I/O Connector

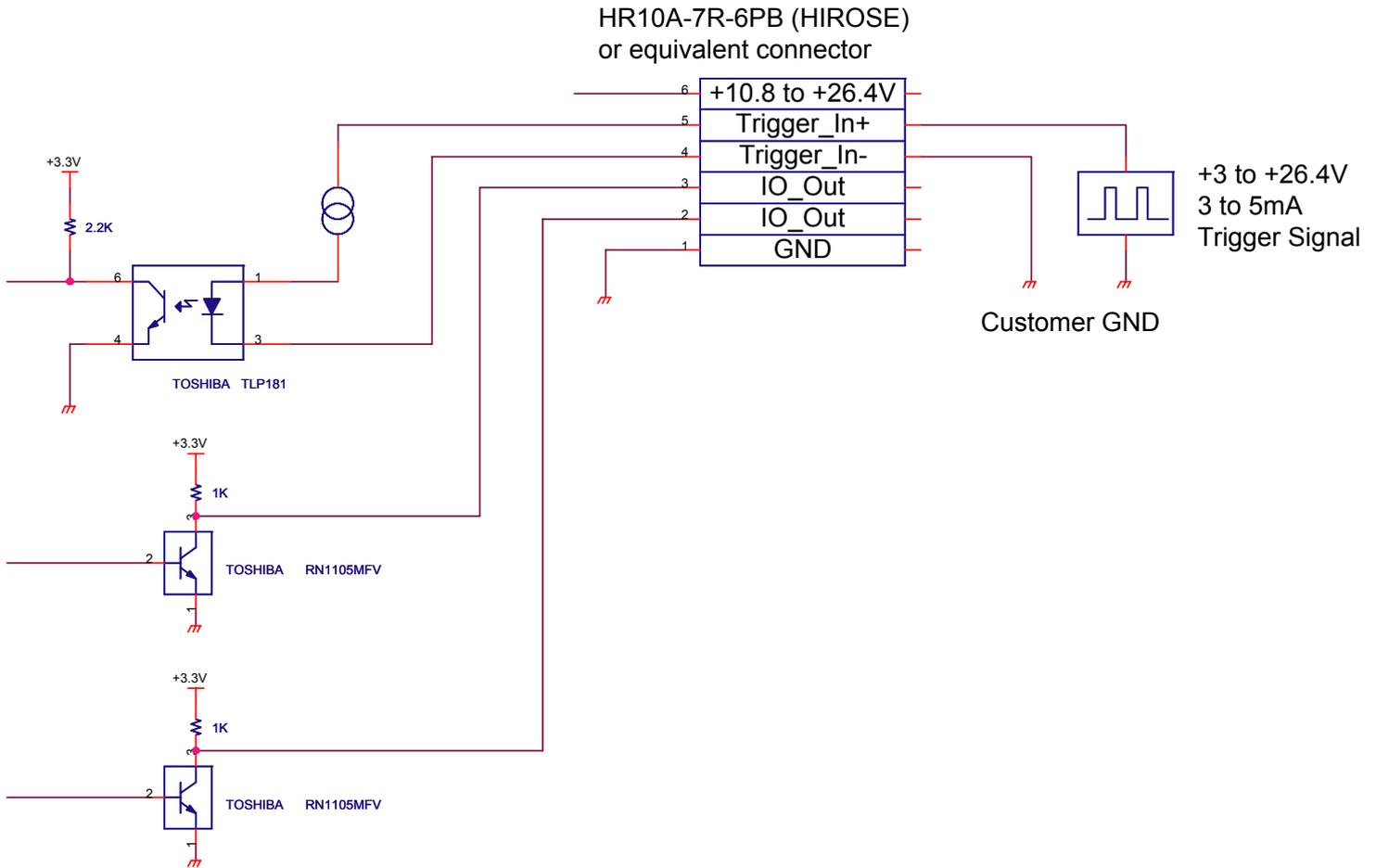

## 2 Camera Output Timing Charts

### 2.1 Horizontal Timing

1 CLK = 27.1605 nseconds

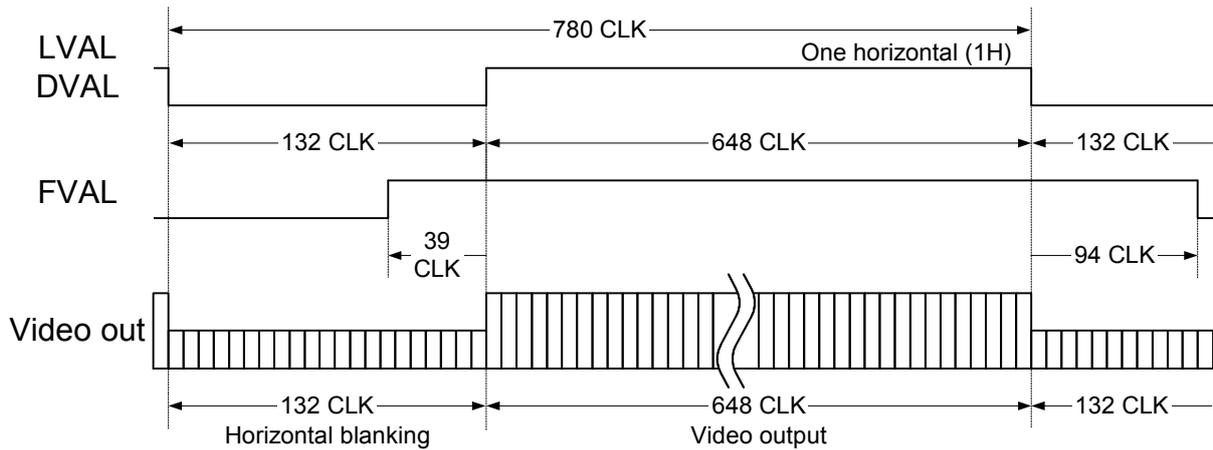

### 2.2 Vertical Timing

#### 2.2.1 Full Scanning

1 H = 21.1852 μseconds, 89.910172 Hz

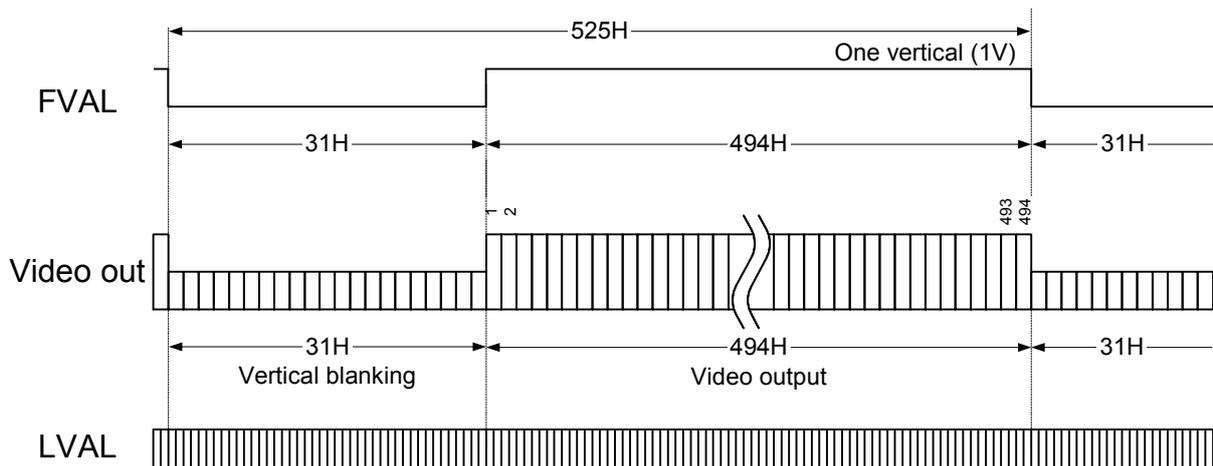

## 2.2.2 AOI (Area of Interest)

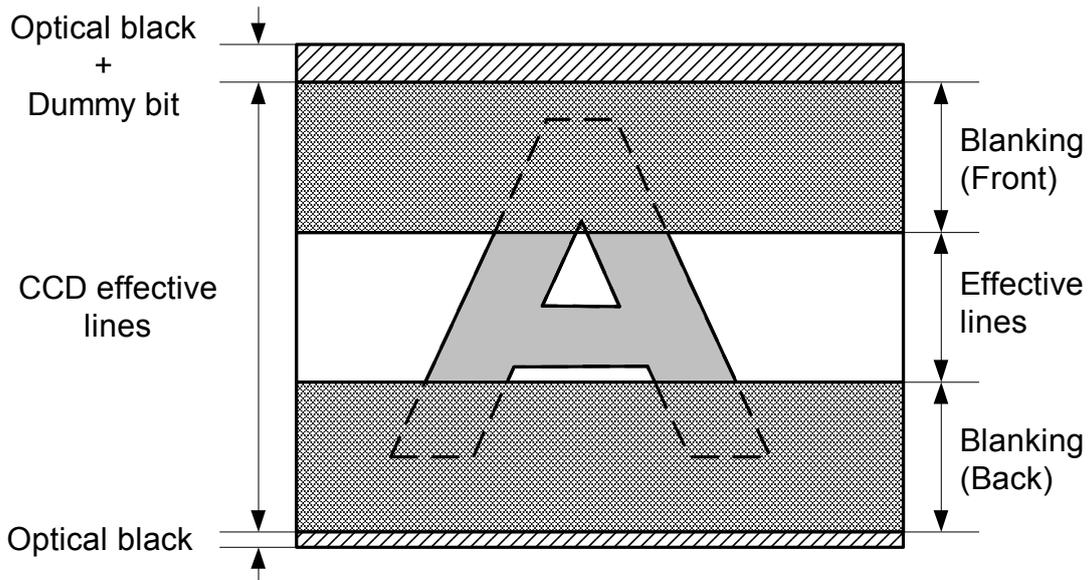
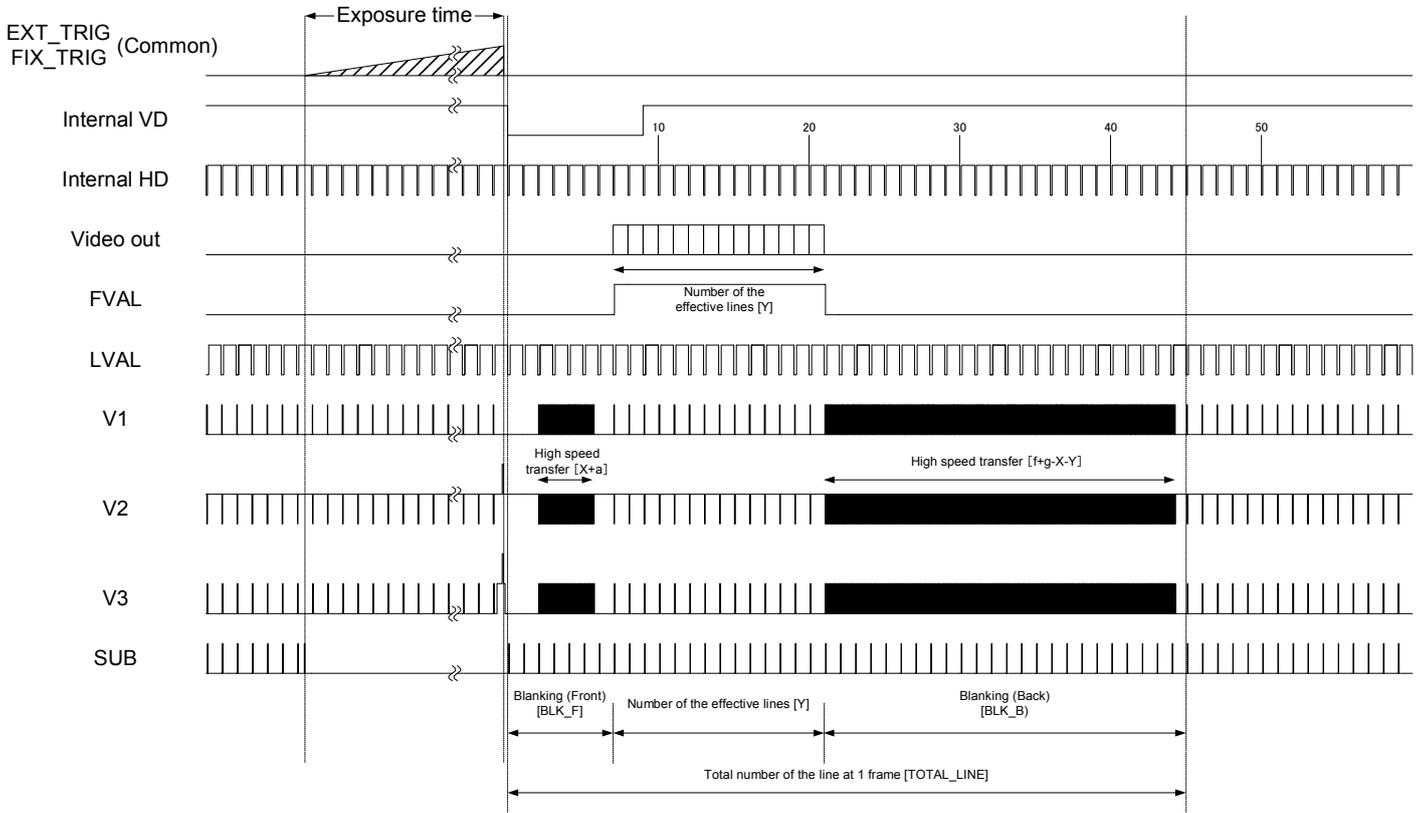

## 2.3 Pixel Transferring Image

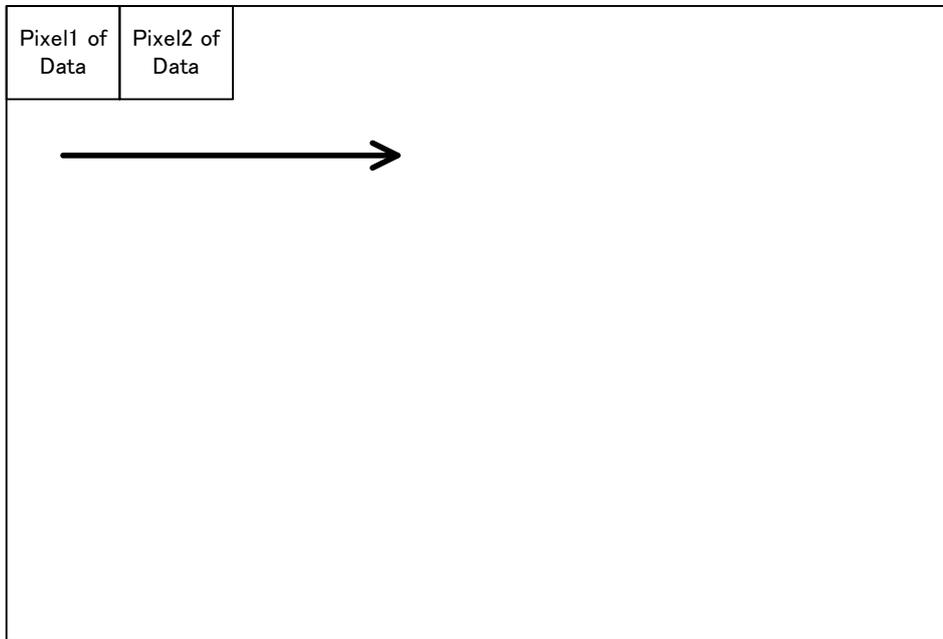

Pixel (n) of Data: nth pixel being transferred

## 3 Camera Operational Modes

### 3.1 Normal Mode

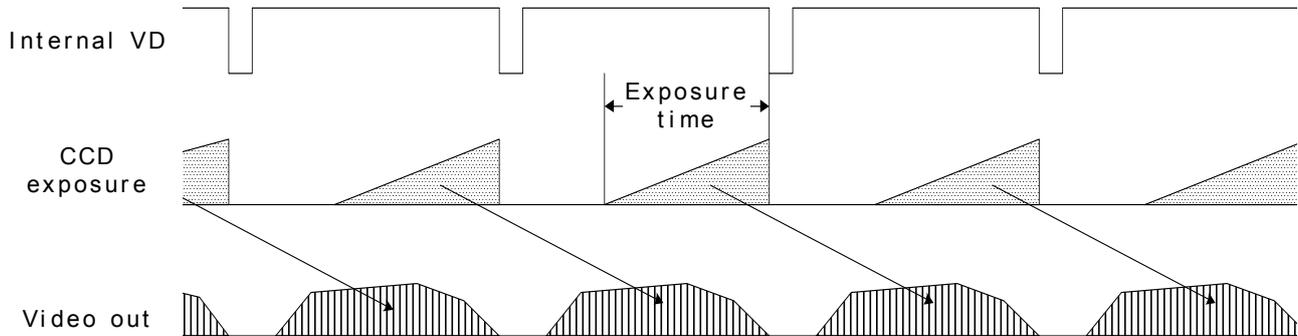

### 3.2 Pulse Width Trigger Mode

In this trigger mode with positive polarity, the camera exposure starts at the rising edge of the trigger pulse and stops at the falling edge of the trigger pulse. Therefore, if positive polarity exposure is selected, the exposure periods are the high states of the trigger pulse.

#### 3.2.1 Timing

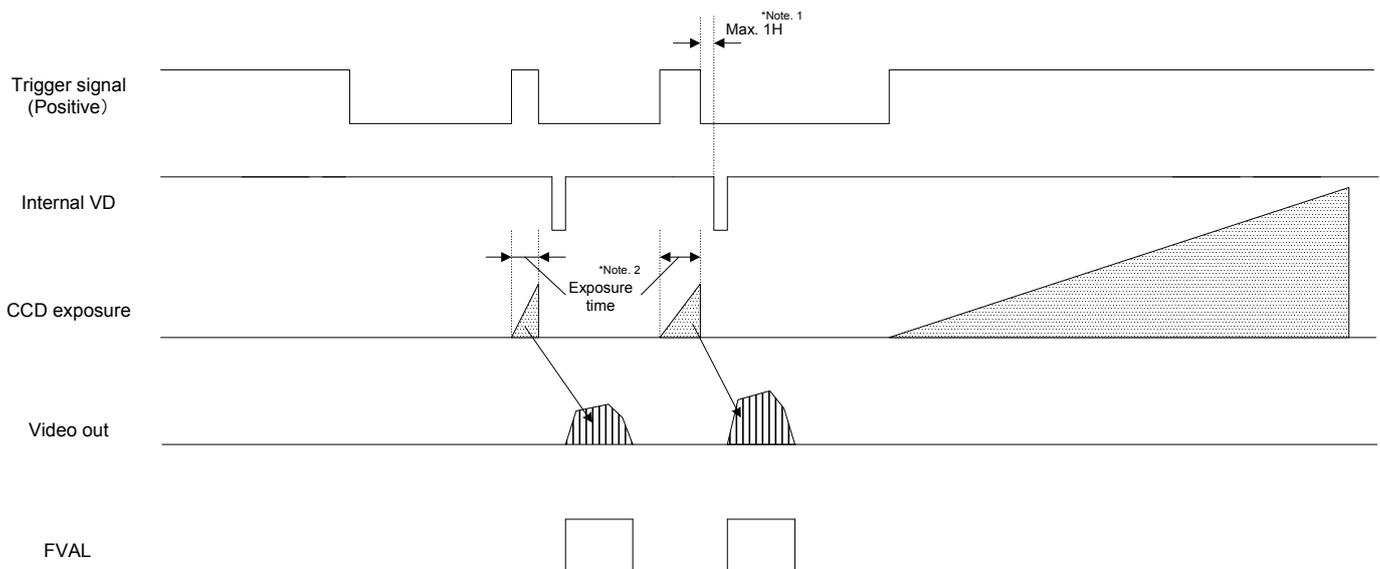

Note 1: The video output is going to be V reset by the next internal HD signal immediately after the exposure is finished.

The exposure time is set by the pulse width of the trigger signal.

Note 2: The FVAL signal does not output when the exposure by the trigger signal does not exist.

### 3.2.2 Exposure Timing with the Positive Polarity Trigger Signal

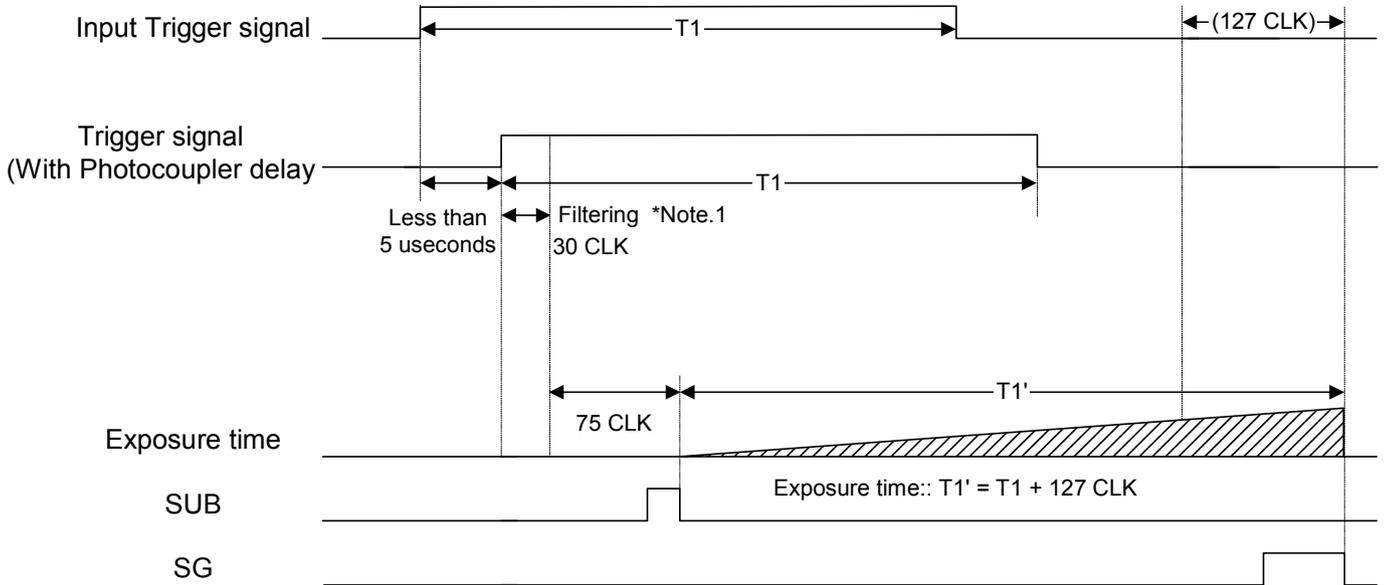

Note 1: The trigger signal will be removed by the filtering if the pulse width of the input trigger signal is less than 30 CLK. Please input a trigger signal with more than 31 CLK pulse width.

Note 2: The exposure will start 105 CLK after the rising edge of the trigger signal.

### 3.2.3 Exposure Timing with the Negative Polarity Trigger Signal

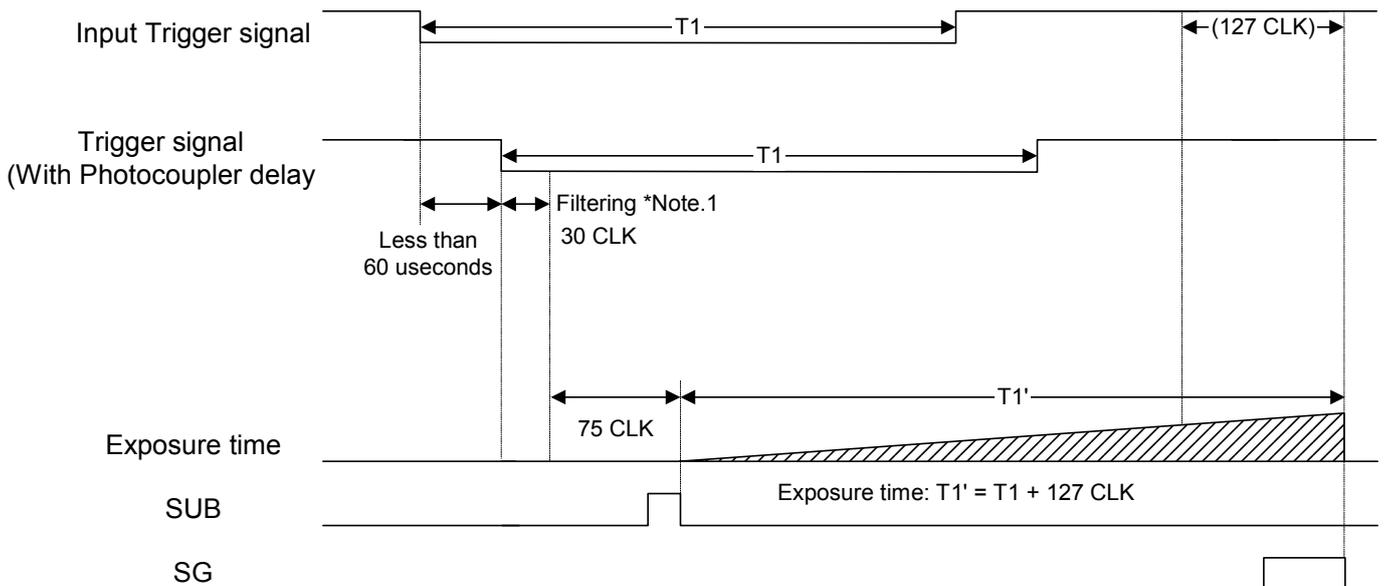

Note 1: The trigger signal will be removed by the filtering if the pulse width of the input trigger signal is less than 30 CLK. Please input a trigger signal with more than 31 CLK pulse width.

Note 2: The exposure will start 105 CLK after the rising edge of the trigger signal.

## 3.3 Edge Preset Trigger Mode

In this “edge preset trigger mode”, the camera exposure starts at the rising edge of the trigger signal like the “pulse width trigger mode” in the previous sections. However, in this mode, the exposure duration time is based on the preset value stored by the camera setting communication.

### 3.3.1 Timing

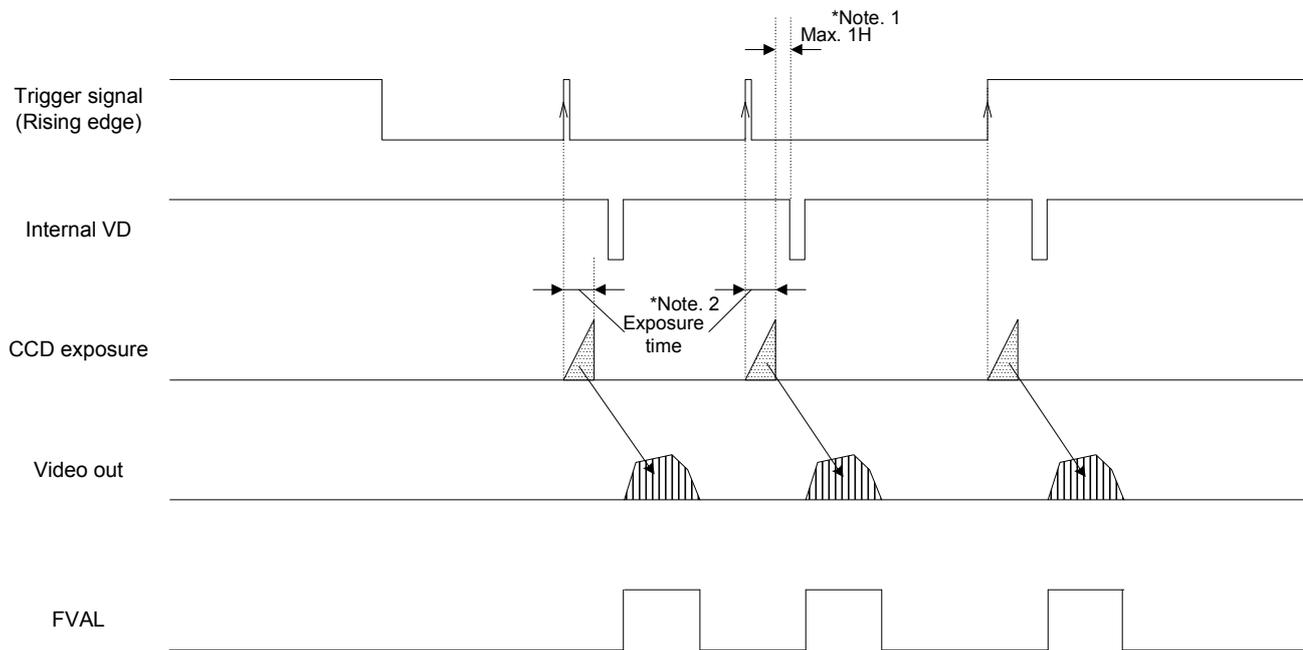

Note 1: The video output will be V reset by the next internal HD signal immediately after the exposure is finished.

Note 2: The exposure time is set by the preset electronic shutter speed.

## 3.3.2 Exposure Timing with the Positive Polarity Trigger Signal

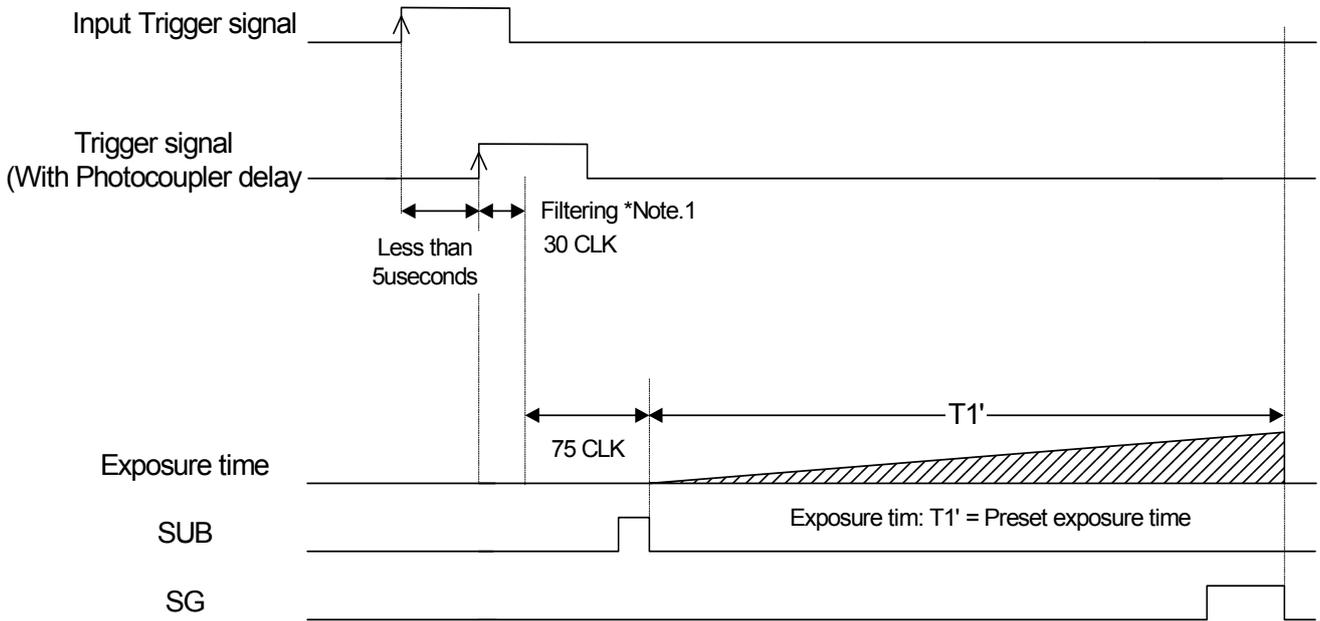

Note 1: The trigger signal will be removed by the filtering if the pulse width of the input trigger signal is less than 30 CLK. Please input a trigger signal with more than 31 CLK pulse width.

Note 2: The exposure will start 105 CLK after the rising edge of the trigger signal.

## 3.3.3 Exposure Timing with the Negative Polarity Trigger Signal

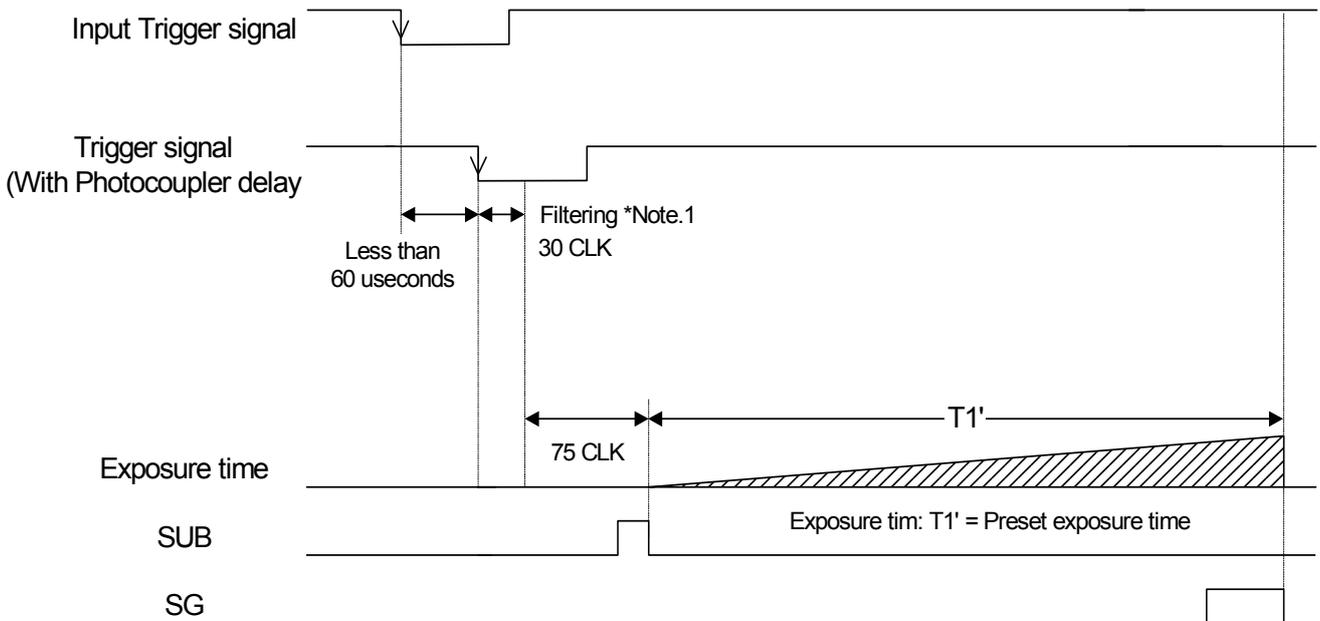

Note 1: The trigger signal will be removed by the filtering if the pulse width of the input trigger signal is less than 30 CLK. Please input a trigger signal with more than 31 CLK pulse width.

Note 2: The exposure will start 105 CLK after the rising edge of the trigger signal.

## 3.4 Edge Preset Trigger Mode (Trigger Input While the Image Is Out)

In this trigger mode, the camera exposure starts at the rising edge of the trigger pulse.

**If trigger signal input is required while the image is out, then it is necessary to disable the trigger signal mask with the communication.**

**To avoid generating additional noise on the image, it is necessary to set the “H reset” at the exposure start mode.**

### 3.4.1 Timing

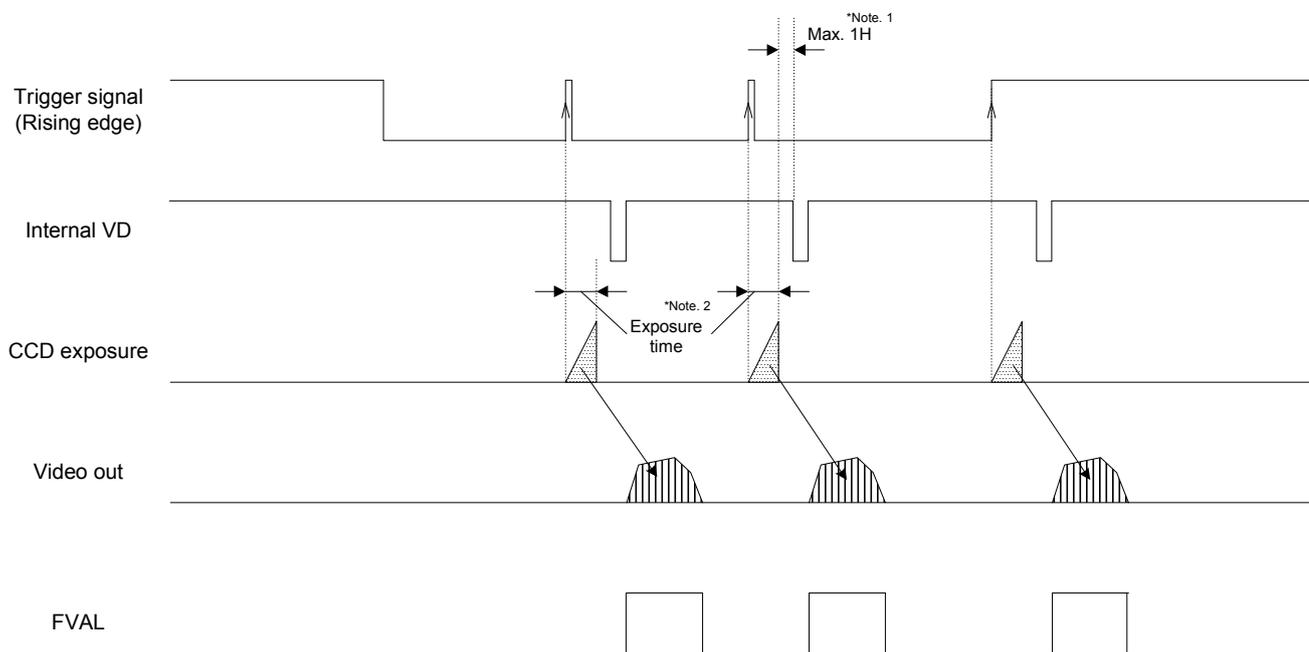

Note 1: The video output will be V reset by the next internal HD signal immediately after the exposure is finished.

Note 2: The exposure time is set by the preset electronic shutter speed.

## 3.4.2 Exposure Timing with the Positive Polarity Trigger Signal

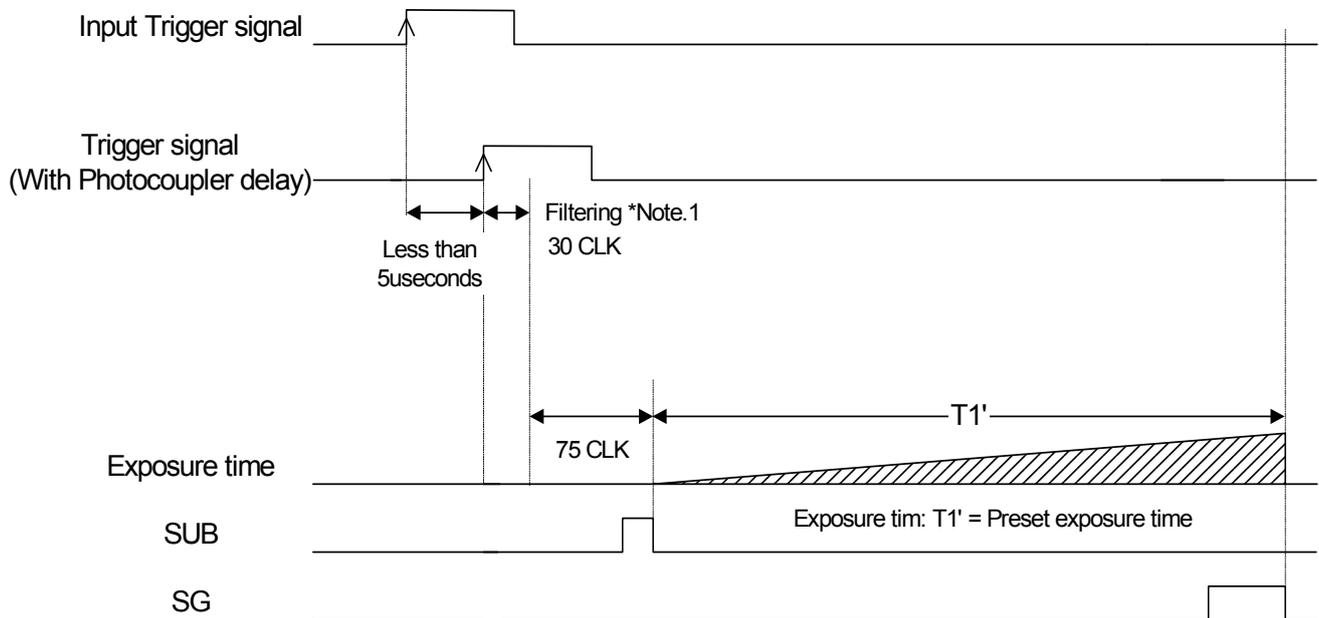

Note 1: The trigger signal will be removed by the filtering if the pulse width of the input trigger signal is less than 30 CLK. Please input a trigger signal with more than 31 CLK pulse width.

Note 2: The exposure will start 105 CLK after the rising edge of the trigger signal.

## 3.4.3 Exposure Timing with the Negative Polarity Trigger Signal

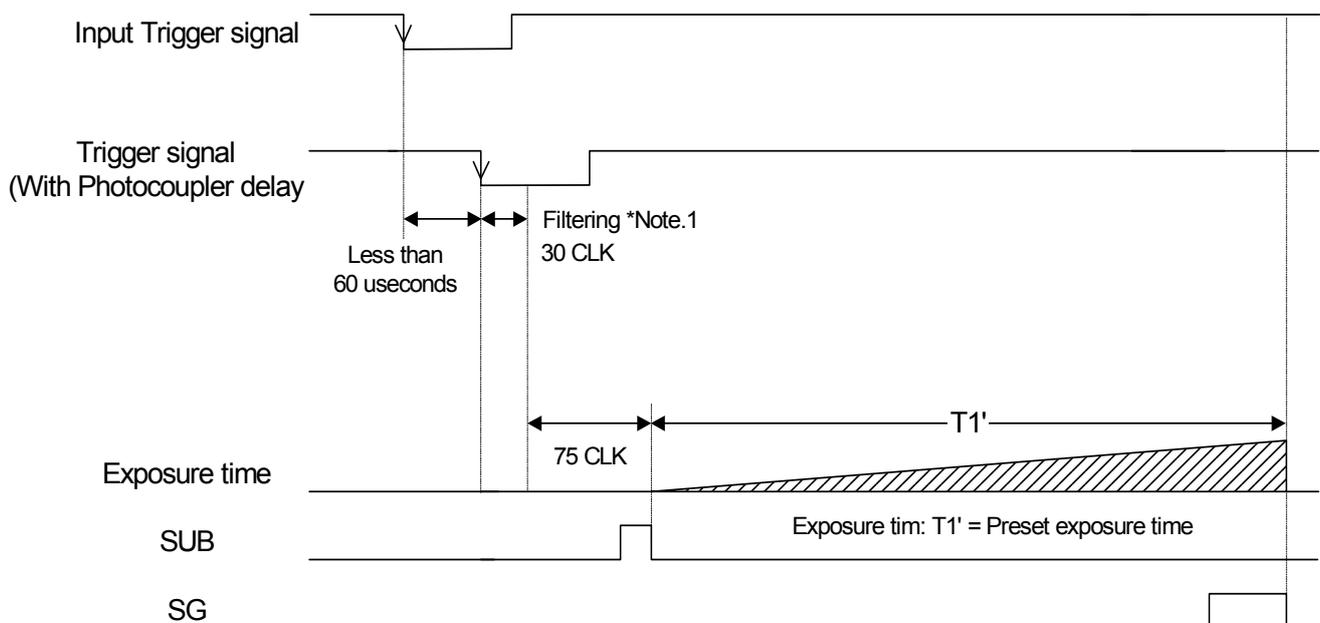

Note 1: The trigger signal will be removed by the filtering if the pulse width of the input trigger signal is less than 30 CLK. Please input a trigger signal with more than 31 CLK pulse width.

Note 2: The exposure will start 105 CLK after the rising edge of the trigger signal.

## 3.5 H Reset Mode

In this mode, the exposure can be start during the video is out from the camera without the horizontal noises. Therefore, generates the SUB pulse to sweep the charges during the horizontal blanking to prevent from getting horizontal noises.

The image is getting the horizontal noises caused by generates the SUB pulse during the video out in normal mode, which is this mode is OFF.

The maximum delay to start exposure from the trigger input is 1H.

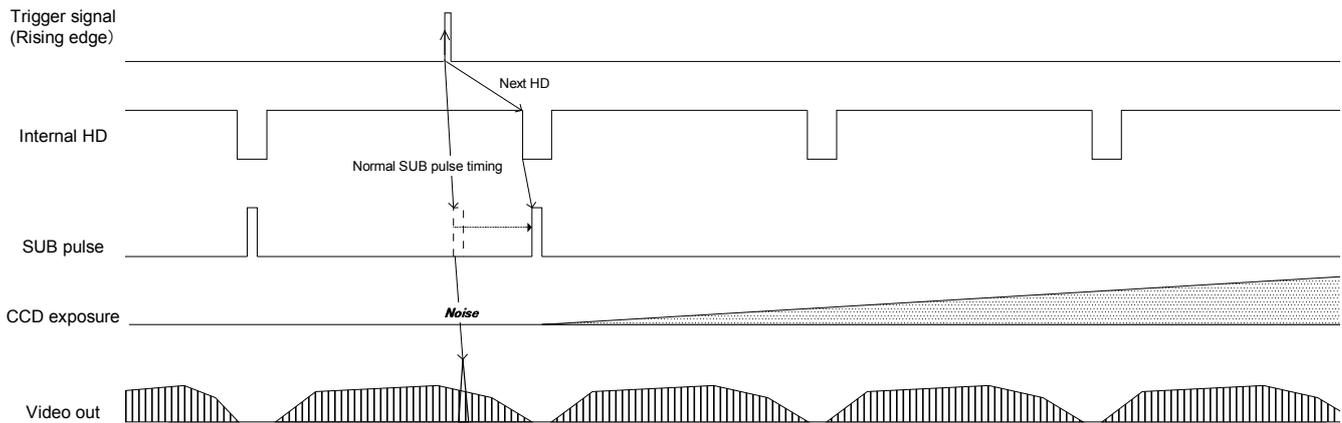

## 4 Communication Protocol

This camera has a communication function that enables external devices, such as a PC, to control the camera's functions.

Please use the "R-GigE-Software" communication software, or the following communication protocol to communicate to the camera:

### 4.1 Communication Method

UART (RS232C) ,binary communication

### 4.2 Communication Settings

	Settings
Baud Rate	115,200 bps
Data Bit	8 bit
Parity	None
Stop Bit	1 bit
Flow Control	None

### 4.3 Communication Format

The Sending data format from the PC to the camera is as follows:

SOF	Device Code	Read/Write	Page Selection	Command Code	Data Length	Data	EOF
(8bit)	(6bit)	(1bit)	(1bit)	(8bit)	(8bit)	(R: 1 byte, dummy) (W: n bytes)	(8bit)

The Receiving Data format from the camera is as follows:

- After sending the Write Command:

SOF	Data Length	Receiving Code	EOF
(8bit)	(8bit) "00H"	(1 byte)	(8bit)

- After sending the Read Command:

SOF	Data Length	Data	EOF
(8bit)	(8bit)	(n bytes)	(8bit)

The description of the format is as follows.

Name	Descriptions
SOF	Start of Frame. Always set or receive the value as "02H"
Device Code	This indicates the destination of communication.  Set "000000" when accessing the camera's function settings Set "100000" when accessing the camera's extended function settings. Please refer to the "Camera Command List" and "Description of the Camera Control Commands".
Read / Write	This specifies "Read" or "Write" to command numbers.  Set (or receive) "0" to send the read command. Set (or receive) "1" to send the write command.
Page Selection	This specifies page selection (access selection to registers or EEPROM) of command.  Set "0" to access the command register of the camera. Read command: To obtain the current data from the command register. Write command: To set a data into the command register. <u>The previously stored data is replaced by this data. However, the data in the EEPROM is not replaced.</u>  Set "1" to access the EEPROM of the camera. Read command: To read stored data from the EEPROM. Write command: To store data into the EEPROM as default value. The camera returns the receiving code "01H" to the PC after storing data in the EEPROM.
Command Code	This indicates the contents of the data sent or received. Refer to the following page for the details.
Data Length	This indicates the data length (unit: byte).  Receiving Frame: The data length is dependent on each read command sent. The data length is defined as "00H" when sending the write command. The data length of error response is defined as "00H".  Sending frame: The data length is 1 byte dummy data when sending the read command, and that data is not referenced. The data length is dependent on each "write command" sent.
Data	This indicates write data or read data according to command type.
EOF	End of Frame. Always set or receive the value as "03H"
Receiving Code	This indicates results of the command sent  01H: OK (ACK), 10H: NG (NAC), 12H: Command number error (Not matching), 13H: Communication frame error (only for Gamma data upload), 14H: Time out error (Two seconds), 15H: Check sum error (only for Gamma data upload), 16H: Data length error (Not matching), 17H: EEPROM write error

## 【Example Code】 Reading the data from the command 00H

- Command to send: 02H, 00H, 00H, 01H, 00H, 03H

SOF	Device Code	Read/Write	Page Selection	Command Code	Data Length	Data	EOF
(8bit)	(6bit)	(1bit)	(1bit)	(8bit)	(8bit)	(1byte)	(8bit)
<b>02H</b>	<b>00H</b>			<b>00H</b>	<b>01H</b>	<b>00H</b>	<b>03H</b>

- Command to receive upon a successful communication: 02H, 01H, 00H, 03H (assuming the data is 00H)

SOF	Data Length	Data	EOF
(8bit)	(8bit)	(n bytes)	(8bit)
<b>02H</b>	<b>01H</b>	<b>00H</b>	<b>03H</b>

## 【Sequence for the saving commands to the EEPROM】

Please use the following sequence for saving the commands to the EEPROM.

- 1) Set "1" to the 80H.0 to enable writing to the EEPROM.
- 2) Send the save data with the page selection "1".
- 3) The camera sends back one of the following receiving codes after writing the EEPROM.  
01H: OK  
17H: EEPROM write error
- 4) 80.0H is cleared to "0" automatically after writing the EEPROM.

Note1: The data cannot be saved to the EEPROM when 80H.0 is "0".

Note2: When saving the consecutive sequence of commands, the above steps, 1) to 4), are necessary only once.

i.e.) saving the commands "10H, 11H, 12H, 13H", or "22H, 23H, 24H", etc.

Note3: When saving the non-consecutive sequence of commands, the above steps, 1) to 4), are necessary for the same number of times.

i.e.) saving the commands "10H, 13H, 19H, 1BH" or "20H, 23H, 25H", etc.

## 4.4 Camera Control Command

- The data unit of the each command is 1 byte (8bit).
- The data can be saved to the EEPROM if there is an “X” in the “Save to EEPROM” column in the following list.
- The camera initializes based on the stored data in the EEPROM when the power is applied.

### 4.4.1 Camera Command List (Device Code: 000000)

Device Code = 000000					
Command No.	R/W	Save to EEPROM	Function	Initial Data	Data Range
00 to 0FH			<i>Reserved</i>	-	-
10H	R/W	x	<i>camera function mode 1 (8bit: D[7..0])</i>	89H	
11H	R/W	x	<i>camera function mode 2 (8bit: D[7..0])</i>	0FH	
12H	R/W	x	<i>camera function mode 3 (8bit: D[7..0])</i>	00H	
13H	R/W	x	<i>camera function mode 4 (8bit: D[7..0])</i>	60H	
14 to 15H			<i>reserved</i>	-	-
16H	R/W	x	<i>software trigger mode (8bit: D[7..0])</i>	80H	
17H	R/W	x	<i>image data reset (8bit: D[7..0])</i>	00H	
18H			<i>reserved</i>	-	-
19H	R/W	x	<i>image output format (8bit: D[7..0])</i>	01H	
1A to 1FH			<i>reserved</i>	-	-
20H	R/W	x	<i>exposure time (us) of the electronic shutter (24bit: D[7..0])</i>	0	0 to 16,777,215
21H	R/W	x	<i>exposure time (us) of the electronic shutter (24bit: D[15..8])</i>		
22H	R/W	x	<i>exposure time (us) of the electronic shutter (24bit: D[24..16])</i>		
23 to 2FH			<i>reserved</i>	-	-
30H	R/W	x	<i>CDS gain (8bit: D[7..0])</i>	0	0 to 255
31H	R/W	x	<i>digital gain (8bit: D[7..0])</i>	factory adjusted value	-
32H	R/W	x	<i>gain offset (8bit: D[7..0])</i>		-
33 to 37H			<i>reserved</i>	-	-
38H	R/W	x	<i>clamp level (8bit: D[7..0])</i>	9	0 to 31
39 to 3DH			<i>reserved</i>	-	-
3EH	R/W	x	<i>white clip for the test pattern (16bit: D[15..8])</i>	4,095	0 to 4,095
3FH	R/W	x	<i>white clip for the test pattern (16bit: D[7..0])</i>		
40 to 4FH			<i>reserved</i>	-	-
50H	R/W	x	<i>trigger delay time (us) (Integer) (24bit: D[7..0])</i>	0	0 to 2,000,000
51H	R/W	x	<i>trigger delay time (us) (Integer) (24bit: D[15..8])</i>		
52H	R/W	x	<i>trigger delay time (us) (Integer) (24bit: D[23..16])</i>		
53H	R/W	x	<i>trigger delay time (us) (Decimal) (8bit: D[7..0])</i>		
54H	R/W	x	<i>strobe signal delay time (us) (Integer) (24bit: D[7..0])</i>	0	0 to 2,000,000
55H	R/W	x	<i>strobe signal delay time (us) (Integer) (24bit: D[15..8])</i>		
56H	R/W	x	<i>strobe signal delay time (us) (Integer) (24bit: D[23..16])</i>		
57H	R/W	x	<i>strobe signal delay time (us) (Decimal) (8bit: D[7..0])</i>		

## Device Code = 000000

Command No.	R/W	Save to EEPROM	Function	Initial Data	Data Range
58H	R/W	x	frame rate (Hz) (Integer) (16bit: D[7..0])	89.91172	0.72028 to 360.33325
59H	R/W	x	frame rate (Hz) (Integer) (16bit: D[15..8])		
5AH	R/W	x	frame rate (Hz) (Decimal) (24bit: D[7..0])		
5BH	R/W	x	frame rate (Hz) (Decimal) (24bit: D[15..8])		
5CH	R/W	x	frame rate (Hz) (Decimal) (24bit: D[23..16])		
5DH	R/W	x	I/O signal polarity (8bit: D[7..0])	00H	
5EH	R/W	x	gain base offset (16bit : D[7..0])	304	0 to 1,023
5FH	R/W	x	gain base offset (16bit : D[15..8])		
60 to 77H			reserved	-	-
78H	R/W	x	test pattern selection (8bit: D[7..0])	00H	
79H	R/W	x	image effect selection (8bit: D[7..0])	00H	
7A to 7FH			reserved	-	-
80H	R/W		EEPROM control (8bit: D[7..0])	00H	
81 to 8FH			reserved	-	-
90H	R/W	x	strobe signal active time (us) (Integer) (24bit: D[7..0])	10	0 to 2,000,000
91H	R/W	x	strobe signal active time (us) (Integer) (24bit: D[15..8])		
92H	R/W	x	strobe signal active time (us) (Integer) (24bit: D[23..16])		
93H	R/W	x	strobe signal active time (us) (Decimal) (8bit: D[7..0])		
94 to EFH			reserved	-	-
F0H	R/W	x	signals of the power-I/O connector (8bit: D[7..0])	20H	
F1H	R/W	x	user output signal for the power-I/O connector (8bit: D[7..0])	00H	
F2 to FFH			reserved	-	-

## 4.4.2 Camera Command List (Device Code: 100000)

Device Code = 100000					
Command No.	R/W	Save to EEPROM	Function	Initial Data	Data Range
00 to 1FH			<i>reserved</i>	-	-
20H	R/W	x	<i>exposure mode (8bit: D[7..0])</i>	00H	
21H	R/W	x	<i>AGC maximum limit (8bit: D[7..0])</i>	255	0 to 255
22H			<i>reserved</i>	-	-
23H	R/W	x	<i>upper limit of the auto electronic shutter (20bit: D[7..0])</i>	11,122	0 to 16,777,215
24H	R/W	x	<i>upper limit of the auto electronic shutter (20bit: D[15..8])</i>		
25H	R/W	x	<i>upper limit of the auto electronic shutter (20bit: D[20..16])</i>		
26H	R/W	x	<i>lower limit of the auto electronic shutter (20bit: D[7..0])</i>	1	0 to 16,777,215
27H	R/W	x	<i>lower limit of the auto electronic shutter (20bit: D[15..8])</i>		
28H	R/W	x	<i>lower limit of the auto electronic shutter (20bit: D[20..16])</i>		
29H	R/W	x	<i>weight1 for ALC (8bit: D[7..0])</i>	11H	D3 to D0: 0 to 15 D7 to D4: 0 to 15
2AH	R/W	x	<i>weight2 for ALC (8bit: D[7..0])</i>	11H	
2BH	R/W	x	<i>weight3 for ALC (8bit: D[7..0])</i>	1AH	
2CH	R/W	x	<i>weight4 for ALC (8bit: D[7..0])</i>	11H	
2DH	R/W	x	<i>weight5 for ALC (8bit: D[7..0])</i>	01H	D3 to D0: 0 to 15 D7 to D4: 0
2EH	R/W	x	<i>target brightness for ALC (8bit: D[7..0])</i>	128	0 to 255
2FH	R/W	x	<i>ALC peak-average (8bit: D[7..0])</i>	0	0 to 255
30H	R/W	x	<i>vertical_1 position for the ALC weight area (16bit: D[7..0])</i>	32	0 to 493
31H	R/W	x	<i>vertical_1 position for the ALC weight area (16bit: D[15..8])</i>		
32H	R/W	x	<i>vertical_2 position for the ALC weight area (16bit: D[7..0])</i>	196	0 to 493
33H	R/W	x	<i>vertical_2 position for the ALC weight area (16bit: D[15..8])</i>		
34H	R/W	x	<i>vertical_3 position for the ALC weight area (16bit: D[7..0])</i>	298	0 to 493
35H	R/W	x	<i>vertical_3 position for the ALC weight area (16bit: D[15..8])</i>		
36H	R/W	x	<i>vertical_4 position for the ALC weight area (16bit: D[7..0])</i>	462	0 to 493
37H	R/W	x	<i>vertical_4 position for the ALC weight area (16bit: D[15..8])</i>		
38H	R/W	x	<i>horizontal_1 position for the ALC weight area (16bit: D[7..0])</i>	36	0 to 647
39H	R/W	x	<i>horizontal_1 position for the ALC weight area (16bit: D[15..8])</i>		
3AH	R/W	x	<i>horizontal_2 position for the ALC weight area (16bit: D[7..0])</i>	252	0 to 647
3BH	R/W	x	<i>horizontal_2 position for the ALC weight area (16bit: D[15..8])</i>		
3CH	R/W	x	<i>horizontal_3 position for the ALC weight area (16bit: D[7..0])</i>	396	0 to 647
3DH	R/W	x	<i>horizontal_3 position for the ALC weight area (16bit: D[15..8])</i>		
3EH	R/W	x	<i>horizontal_4 position for the ALC weight area (16bit: D[7..0])</i>	612	0 to 647
3FH	R/W	x	<i>horizontal_4 position for the ALC weight area (16bit: D[15..8])</i>		
40 to 4FH			<i>reserved</i>	-	-
50H	R/W	x	<i>Y_offset for AOI (8bit: D[7..0])</i>	0	2 ≤ Y ≤ 494, where Y = offset + height
51H	R/W	x	<i>Y_offset for AOI (16bit: D[15..8])</i>		
52H	R/W	x	<i>height for AOI (8bit: D[7..0])</i>	494	
53H	R/W	x	<i>height for AOI (16bit: D[15..8])</i>		

Device Code = 100000						
Command No.	R/W	Save to EEPROM	Function	Initial Data	Data Range	
54H	R/W	x	<i>X_offset for AOI (8bit: D[7..0])</i>	0	8 ≤ X ≤ 648, where X = offset + width	
55H	R/W	x	<i>X_offset for AOI (16bit: D[15..8])</i>			
56H	R/W	x	<i>width for AOI (8bit: D[7..0])</i>	648		
57H	R/W	x	<i>width for AOI (16bit: D[15..8])</i>			
58 to 5FH			<i>reserved</i>	-		-
60H	R/W	x	<i>camera mode1 (8bit: D[7..0])</i>	00H		
61 to 91H			<i>reserved</i>	-	-	
92H	R/W	x	<i>iris lens manual adjustment (8bit: D[7..0])</i>	01H		
93 to FFH			<i>reserved</i>	-	-	

## 4.4.3 Descriptions of the Camera Control Commands (Device code: 000000); (The underline settings are the factory default settings)

Command No.	Command Description								
10H: MOD1[7..0]	<p>[camera function mode 1] Initial data: MOD1[7..0] = 89H Sets the camera function mode. D[7..0]</p> <table border="1"> <tr> <td>D7</td><td>D6</td><td>D5</td><td>D4</td><td>D3</td><td>D2</td><td>D1</td><td>D0</td> </tr> </table> <p>D7: No Function <u>Always set as "1"</u>  D6: Trigger Polarity <u>0: Positive</u> 1: Negative  D5: Trigger Mode <u>0: Edge Preset</u> 1: Pulse Width  D4: Binning Mode <u>0: OFF (Normal)</u> 1: ON (Binning)  D3 to D0: No Function <u>Always set as "1001"</u></p> <p>Note 1: The trigger polarity is automatically set to positive when using the software trigger; the trigger polarity cannot be changed.</p>	D7	D6	D5	D4	D3	D2	D1	D0
D7	D6	D5	D4	D3	D2	D1	D0		
11H: MOD2[7..0]	<p>[Camera function mode 2] Initial data: MOD2[7..0] = 0FH Sets the camera function mode. D[7..0]</p> <table border="1"> <tr> <td>D7</td><td>D6</td><td>D5</td><td>D4</td><td>D3</td><td>D2</td><td>D1</td><td>D0</td> </tr> </table> <p>D7 to D5: No Function <u>Always set as "000"</u>  D4: Smear Half Reduction <u>0: OFF</u> 1: ON  D3: Operational Mode <u>0: Trigger Mode</u> 1: <u>Continuous Mode</u>  D2 to D0: No Function <u>Always set as "111"</u></p> <p>Note 1: The function mode is enabled whenever the "Continuous/Trigger mode (MOD1-D7)" is manual.  Note 2: While the camera is in Trigger Mode, the video will not output without the trigger signal input.</p>	D7	D6	D5	D4	D3	D2	D1	D0
D7	D6	D5	D4	D3	D2	D1	D0		
12H: MOD3[7..0]	<p>[Camera function mode 3] Initial data: MOD3[7..0] = 00H Sets the camera function mode. D[7..0]</p> <table border="1"> <tr> <td>D7</td><td>D6</td><td>D5</td><td>D4</td><td>D3</td><td>D2</td><td>D1</td><td>D0</td> </tr> </table> <p>D7 to D6: No Function <u>Always set as "00"</u>  D5: Trigger Signal Type <u>0: Software Trigger</u> 1: Hardware Trigger  (from No.5 pin of Power-I/O connector)  D4 to D3: Exposure Start Mode <u>00: Normal</u> 10 to 11: H Reset  01: No Function (Prohibited setting. Do not set these values)  D2 to D0: No Function <u>Always set as "000"</u></p> <p>Note 1: The trigger polarity is automatically set to positive when using the software trigger; the trigger polarity cannot be changed.</p>	D7	D6	D5	D4	D3	D2	D1	D0
D7	D6	D5	D4	D3	D2	D1	D0		

Command No.	Command Description								
13H: MOD4[7..0]	<p>[Camera function mode 4] Initial data: MOD4[7..0] = 60H Sets the camera function mode.</p> <p>D[7..0]</p> <table border="1" data-bbox="280 461 868 499"> <tr> <td>D7</td><td>D6</td><td>D5</td><td>D4</td><td>D3</td><td>D2</td><td>D1</td><td>D0</td> </tr> </table> <p>D7: No Function <u>Always set as "0"</u></p> <p>D6: Trigger signal mask during exposure 0: OFF (No mask) <u>1: ON (Mask)</u></p> <p>D5: Trigger signal mask during image output 0: OFF (No mask) <u>1: ON (Mask)</u></p> <p>D4 to D0: No Function <u>Always set as "100000"</u></p> <p>Note 1: The trigger signal is invalidated when mask function is on.</p>	D7	D6	D5	D4	D3	D2	D1	D0
D7	D6	D5	D4	D3	D2	D1	D0		
16H: SOFTRG[7..0]	<p>[Software Trigger Setting] Initial data: SOFTRG[7..0] = 80H Sets the source of the software trigger.</p> <p>D[7..0]</p> <table border="1" data-bbox="280 864 868 902"> <tr> <td>D7</td><td>D6</td><td>D5</td><td>D4</td><td>D3</td><td>D2</td><td>D1</td><td>D0</td> </tr> </table> <p>D7 to D6: Software trigger source selection 00: Programming software trigger <u>10: Command software trigger</u> (200 useconds pulse width trigger signal) 01, 11: No function (Prohibited settings. Do not set these values)</p> <p>D5 to D1: No Function <u>Always set as "00000"</u></p> <p>D0: Generate software trigger command <u>0: Hold (Low State)</u> 1: Generate command software trigger (200 useconds high state)</p> <p>Note 1: The software trigger source selection is enabled whenever "Trigger signal type (MOD3-D5)" is the software trigger (set as 0)</p> <p>Note 2: The "Programming software trigger" is used to set up the pulse duration, trigger signal interval and generate the trigger signal.</p> <p>Note 3: When selecting "Command software trigger", it is necessary to generate the software trigger signal with the "Generate command software trigger (SOFTRIG-D0)".</p>	D7	D6	D5	D4	D3	D2	D1	D0
D7	D6	D5	D4	D3	D2	D1	D0		
17H: IMAGEREST [7..0]	<p>[Image Data Reset] Initial data: IMAGEREST[7..0] = 00H Reset the Image data (FVAL, LVAL and the image data). Change from the reset to the image data out after starting the image acquisition. The image data is not output when resetting the image data.</p> <p>D[7..0]</p> <table border="1" data-bbox="280 1659 868 1697"> <tr> <td>D7</td><td>D6</td><td>D5</td><td>D4</td><td>D3</td><td>D2</td><td>D1</td><td>D0</td> </tr> </table> <p>D7 to D1: No Function <u>Always set as "0000000"</u></p> <p>D0: Image Data Reset <u>0: FVAL/LVAL/Image data reset</u> (FVAL, LVAL and the image data are low state data) <u>1: FVAL/LVAL/Image data out</u></p>	D7	D6	D5	D4	D3	D2	D1	D0
D7	D6	D5	D4	D3	D2	D1	D0		

Command No.	Command Description																						
19H FORMAT[7..0]	<p>[Image output format] initial data: FORMAT[7..0] = 01H Sets the output format of the image data.</p> <p>D[7..0]</p> <table border="1"> <tr> <td>D7</td> <td>D6</td> <td>D5</td> <td>D4</td> <td>D3</td> <td>D2</td> <td>D1</td> <td>D0</td> </tr> </table> <p>D7 to D3: No Function <u>Always set as "00000"</u></p> <p>D2 to D0: Output format</p> <table> <tr> <td>000: Mono8 (Monochrome)</td> <td>/ BayerRGB8 (Color)</td> </tr> <tr> <td>001: Mono10 (Monochrome)</td> <td>/ BayerRGB10 (Color)</td> </tr> <tr> <td>010: Mono10Packed (Monochrome)</td> <td>/ BayerRGB12 (Color)</td> </tr> <tr> <td>011: Mono12 (Monochrome)</td> <td>/ BayerRGB10Packed (Color)</td> </tr> <tr> <td>100: Mono12Packed (Monochrome)</td> <td>/ BayerRGB12Packed (Color)</td> </tr> <tr> <td>101: No function (Do not set)</td> <td>/ BayerRGB8Packed (Color)</td> </tr> <tr> <td>100 to 111: No function (Prohibited setting. Do not set these values)</td> <td></td> </tr> </table>	D7	D6	D5	D4	D3	D2	D1	D0	000: Mono8 (Monochrome)	/ BayerRGB8 (Color)	001: Mono10 (Monochrome)	/ BayerRGB10 (Color)	010: Mono10Packed (Monochrome)	/ BayerRGB12 (Color)	011: Mono12 (Monochrome)	/ BayerRGB10Packed (Color)	100: Mono12Packed (Monochrome)	/ BayerRGB12Packed (Color)	101: No function (Do not set)	/ BayerRGB8Packed (Color)	100 to 111: No function (Prohibited setting. Do not set these values)	
D7	D6	D5	D4	D3	D2	D1	D0																
000: Mono8 (Monochrome)	/ BayerRGB8 (Color)																						
001: Mono10 (Monochrome)	/ BayerRGB10 (Color)																						
010: Mono10Packed (Monochrome)	/ BayerRGB12 (Color)																						
011: Mono12 (Monochrome)	/ BayerRGB10Packed (Color)																						
100: Mono12Packed (Monochrome)	/ BayerRGB12Packed (Color)																						
101: No function (Do not set)	/ BayerRGB8Packed (Color)																						
100 to 111: No function (Prohibited setting. Do not set these values)																							
20H: EXPTM[7..0] 21H: EXPTM[15..8] 22H: EXPTM[23..16]	<p>[Exposure time (useconds) of the electronic shutter] Initial data: EXPTM[23..0] = 0, data range: 0 to 16,777,215 Sets the exposure time for the electronic shutter.</p> <p>Exposure time = EXPTM[23..0] useconds</p> <p>When set as 0, the electronic shutter is OFF.</p>																						
30H: PGA[7..0]	<p>[CDS gain] Initial data: PGA [7..0] = 0, data range: 0 to 255 Sets the CDS gain (programmable gain)</p> <p>CDS gain = 6.16 + 0.04 x (PGA[7..0] x 2 + GOFs[7..0])dB</p> <p>*GOFs[7..0]: The gain offset (The value of the address 32H)</p>																						
31H: DGB[7..0]	<p>[Digital gain] Initial data: DGB [7..0] = The factory adjusted value</p> <p>Video level = (Input video level – CLAMP level) x (1 + DGB[7..0]/128) + CLAMP Level</p> <p>*CLAMP Level Clamp level (The calculated value of the address 38H)</p>																						
32H: GOFs[7..0]	<p>[Gain offset] Initial data: GOFs[7..0] = The factory adjusted value, data range: 0 to 255</p>																						
38H: CLAMP[7..0]	<p>[Clamp level] Initial data: CLAMP[7..0] = 9; data range: 0 to 31 Sets the clamp level (The clamp level of the black signal)</p> <p>Clamp level = CLAMP[7..0] x 8 + 56 (for 12bit output) Clamp level = (CLAMP[7..0] x 8 + 56) / 4 (for 10bit output) Clamp level = (CLAMP[7..0] x 8 + 56) / 16 (for 8 bit output)</p> <p>Whenever it is set greater than 31, it will automatically resets to 31.</p>																						

Command No.	Command Description								
3EH: WHITE_CLIP[15..8] 3FH: WHITE_CLIP[7..0]	[White clip level for the white clip test pattern] Initial data: WHITE_CLIP[15..0] = 4,095; data range: 0 to 4,095  Sets the white clip level of the white clip test pattern.								
50H: DELAY_I[7..0] 51H: DELAY_I[15..8] 52H: DELAY_I[23..16] 53H: DELAY_F[7..0]	[Delay time (us) for the trigger signal] Initial data: DELAY_I[23..0] = 0, DELAY_F[7..0] = 0, data range: 0 to 2,000,000 Sets the delay time that is from the trigger signal input to the start of the exposure as useconds.  Delay time for the trigger signal = (DELAY_I[23..0]). (DELAY_F[7..0]) useconds								
54H: STROBEDELAY_I[7..0] 55H: STROBEDELAY_I[15..8] 56H: STROBEDELAY_I[23..16] 57H: STROBEDELAY_F[7..0]	[Delay time (us) for the strobe signal] Initial data: STROBEDELAY_I[23..0] = 0, STROBEDELAY_F[7..0] = 0, data range: 0 to 2,000,000  Delay time for the strobe signal = (STROBEDELAY_I[23..0]). (STROBEDELAY_F[7..0]) useconds								
58H: FPS_I[7..0] 59H: FPS_I[15..8] 5AH: FPS_F[7..0] 5BH: FPS_F[15..8] 5CH: FPS_F[23..16]	[Frame rate (Hz)] Initial data: FPS_I[15..0] = 89, data range: 0 to 360 Initial data: FPS_F[15..0] = 0.91172, data range: 0 to 0.99999 Sets the frame rate as Hz  Frame rate = (FPS_I[15..0]). (FPS_F[23..0]) Hz data range of frame rate: 0.72028 to 360.33325 Hz Maximum frame rate for full resolution: 89.91172 Hz (as initial data)  Note 1: The maximum frame rate depends on the AOI setting Note 2: The maximum frame rate is achieved when the vertical resolution is set 1/4 of the full resolution. The maximum frame rate does not increase even if the vertical resolution is set smaller than 1/4 of the full resolution.								
5DH: IOSIGNAL_POL[7..0]	[I/O signal polarity] Initial data: IOSIGNAL_POL[7..0] = 00H, Sets the No.2 pin and No.3 pin of the I/O signal polarity. D[7..0] <table border="1" style="margin-left: 20px;"> <tr> <td>D7</td><td>D6</td><td>D5</td><td>D4</td><td>D3</td><td>D2</td><td>D1</td><td>D0</td> </tr> </table> D7 to D2: No Function <span style="float: right;"><u>Always set as "000000"</u></span> D1: No.3 pin (I/O-2) polarity <span style="float: right;"><u>0: Non-invert</u> 1: Invert</span> D0: No.2 pin (I/O-1) polarity <span style="float: right;"><u>0: Non-invert</u> 1: Invert</span>	D7	D6	D5	D4	D3	D2	D1	D0
D7	D6	D5	D4	D3	D2	D1	D0		



Command No.	Command Description								
90H: STROBEON_I[7..0] 91H: STROBEON_I[15..8] 92H: STROBEON_I[23..16] 93H: STROBEON_F[7..0]	<p>[Active time (us) for the strobe signal] Initial data: STROBEON_I[23..0] = 10, STROBEDELAY_F[7..0] = 0, data range: 0 to 2,000,000</p> <p>Active time for the strobe signal = (STROBEON_I[23..0]). (STROBEON_F[7..0]) useconds</p> <p>Active time for the strobe signal is set as below.</p> <p>0: No strobe signal output 1 to 9: 10 us Greater than 9: set value</p>								
F0H: OUTSEL [7..0]	<p>[Output signal selection for the power-I/O connector] Initial data: OUTSEL[7..0] = 20H Sets the output signal from the power/I/O connector.</p> <p>D[7..0]</p> <table border="1" data-bbox="360 931 948 969"> <tr> <td>D7</td><td>D6</td><td>D5</td><td>D4</td><td>D3</td><td>D2</td><td>D1</td><td>D0</td> </tr> </table> <p>D7 to D4: Output signal for 3pin of the power/I/O connector</p> <p>0: FrameTriggerWait signal    1: UserOutput signal 2: ExposureActive signal    3: TriggerAuxiliary signal 4: TriggerInternal signal (after mask and delay process) 5: SensorReadOut signal 6 to F: No Function (Prohibited setting. Do not set these values)</p> <p>D3 to D0: Output signal for 2pin of the power/I/O connector</p> <p>0: FrameTriggerWait signal    1: UserOutput signal 2: ExposureActive signal    3: TriggerAuxiliary signal 4: TriggerInternal signal (after mask and delay process) 5: SensorReadOut signal 6 to F: No Function (Prohibited setting. Do not set these values)</p> <p>Note: When "UserOutput signal" is selected, set the status of the signal with "UserOutput signal for the power/I/O connector (TEST2-D3,4)".</p>	D7	D6	D5	D4	D3	D2	D1	D0
D7	D6	D5	D4	D3	D2	D1	D0		
F1H: TEST2[7..0]	<p>[UserOutput signal for the power-I/O connector] Initial data: TEST2[7..0] = 00H Sets the status of the UserOutput signal.</p> <p>D[7..0]</p> <table border="1" data-bbox="360 1630 948 1668"> <tr> <td>D7</td><td>D6</td><td>D5</td><td>D4</td><td>D3</td><td>D2</td><td>D1</td><td>D0</td> </tr> </table> <p>D7 to D5: No function    <u>Always set as "000"</u></p> <p>D4: UserOutput signal for 3pin of the power/I/O connector    0: Low    1: High</p> <p>D3: UserOutput signal for 2pin of the power/I/O connector    0: Low    1: High</p> <p>D2 to D0: No function    <u>Always set as "000"</u></p> <p>Note: The UserOutput signal is enabled whenever "UserOutput signal" is selected at the "Output signal selection (OUTSEL)".</p>	D7	D6	D5	D4	D3	D2	D1	D0
D7	D6	D5	D4	D3	D2	D1	D0		

## 4.4.4 Descriptions of the Camera Commands (Device code: 100000); (The underline settings are the factory default settings)

Command No.	Command Description								
20H: [7..0]	<p>[Exposure mode] Initial data: 00H Sets the exposure mode, which is the AGC, the shutter mode and the iris lens control method. D[7..0]</p> <table border="1"> <tr> <td>D7</td> <td>D6</td> <td>D5</td> <td>D4</td> <td>D3</td> <td>D2</td> <td>D1</td> <td>D0</td> </tr> </table> <p>D7 to D4: No Function <u>Always set as "0000"</u>  D3: AGC <u>0: OFF (Fixed gain)</u> 1: ON (AGC)  D2: Shutter Mode <u>0: OFF (Fixed shutter)</u> 1: ON (Auto shutter)  D1: Iris Lens Control Method <u>0: OFF (Manual control)</u> 1: ON (Auto control)  D0: No Function <u>Always set as "0"</u></p>	D7	D6	D5	D4	D3	D2	D1	D0
D7	D6	D5	D4	D3	D2	D1	D0		
21H: [7..0]	<p>[AGC maximum limit] Initial data: 255, data range: 0 to 255 Sets the maximum limit for the AGC.</p>								
23H: [7..0] 24H: [15..8] 25H: [20..16]	<p>[Upper limit of the electronic shutter for auto shutter] Initial data: 11,122; data range: 0 to 16,777,215 Sets the upper limit of the electronic shutter for the auto shutter as usecond.</p>								
26H: [7..0] 27H: [15..8] 28H: [20..16]	<p>[Lower limit of the electronic shutter for auto shutter] Initial data: 11,122; data range: 0 to 16,777,215 Sets the upper limit of the electronic shutter for the auto shutter as usecond.</p>								
29H: [7..0]	<p>[Weight1 for ALC] Initial data: 11H Sets the weight for ALC weight area 1 and 2. D[7..0]</p> <table border="1"> <tr> <td>D7</td> <td>D6</td> <td>D5</td> <td>D4</td> <td>D3</td> <td>D2</td> <td>D1</td> <td>D0</td> </tr> </table> <p>D7 to D4: Weight for ALC weight area 2 <u>1</u> Range: 0 to 15  D3 to D0: Weight for ALC weight area 1 <u>1</u> Range: 0 to 15</p> <p>*Please set the ALC weight area with "30H to 3FH"</p>	D7	D6	D5	D4	D3	D2	D1	D0
D7	D6	D5	D4	D3	D2	D1	D0		
2AH: [7..0]	<p>[Weight2 for ALC] Initial data: 11H Sets the weight for ALC weight area 3 and 4. D[7..0]</p> <table border="1"> <tr> <td>D7</td> <td>D6</td> <td>D5</td> <td>D4</td> <td>D3</td> <td>D2</td> <td>D1</td> <td>D0</td> </tr> </table> <p>D7 to D4: Weight for ALC weight area 4 <u>1</u> Range: 0 to 15  D3 to D0: Weight for ALC weight area 3 <u>1</u> Range: 0 to 15</p> <p>*Please set the ALC weight area with "30H to 3FH"</p>	D7	D6	D5	D4	D3	D2	D1	D0
D7	D6	D5	D4	D3	D2	D1	D0		

Command No.	Command Description								
2BH: [7..0]	<p>[Weight3 for ALC] Initial data: 1AH Sets the weight for ALC weight area 5 and 6.</p> <p>D[7..0]</p> <table border="1"> <tr> <td>D7</td><td>D6</td><td>D5</td><td>D4</td><td>D3</td><td>D2</td><td>D1</td><td>D0</td> </tr> </table> <p>D7 to D4: Weight for ALC weight area 6 <u>1</u> Range: 0 to 15 D3 to D0: Weight for ALC weight area 5 <u>10</u> Range: 0 to 15</p> <p>*Please set the ALC weight area with "30H to 3FH"</p>	D7	D6	D5	D4	D3	D2	D1	D0
D7	D6	D5	D4	D3	D2	D1	D0		
2CH: [7..0]	<p>[Weight4 for ALC] Initial data: 11H Sets the weight for ALC weight area 7 and 8.</p> <p>D[7..0]</p> <table border="1"> <tr> <td>D7</td><td>D6</td><td>D5</td><td>D4</td><td>D3</td><td>D2</td><td>D1</td><td>D0</td> </tr> </table> <p>D7 to D4: Weight for ALC weight area 8 <u>1</u> Range: 0 to 15 D3 to D0: Weight for ALC weight area 7 <u>1</u> Range: 0 to 15</p> <p>*Please set the ALC weight area with "30H to 3FH"</p>	D7	D6	D5	D4	D3	D2	D1	D0
D7	D6	D5	D4	D3	D2	D1	D0		
2DH: [7..0]	<p>[Weight5 for ALC] Initial data: 01H Sets the weight for ALC weight area 9.</p> <p>D[7..0]</p> <table border="1"> <tr> <td>D7</td><td>D6</td><td>D5</td><td>D4</td><td>D3</td><td>D2</td><td>D1</td><td>D0</td> </tr> </table> <p>D7 to D4: No Function <u>Always set as "0000"</u> D3 to D0: Weight for ALC weight area 9 <u>1</u> Range: 0 to 15</p> <p>*Please set the ALC weight area with "30H to 3FH"</p>	D7	D6	D5	D4	D3	D2	D1	D0
D7	D6	D5	D4	D3	D2	D1	D0		
2EH: [7..0]	<p>[Target Brightness for ALC] Initial data: 128, data range: 0 to 255 Sets the target brightness for the ALC function (AGC, auto shutter or iris lens auto control).</p>								
2FH: [7..0]	<p>[ALC peak-average] Initial data: 0, data range: 0 to 255 Sets the control standard for the ALC function (AGC, auto shutter or iris lens auto control)</p> <p>When set as 0 (Average: 100%, Peak: 0%), the ALC function with the average brightness of the photometry area.</p> <p>When set as 255 (Average: 0%, Peak: 100%), the ALC function with the peak brightness of the photometry area.</p>								

Command No.	Command Description										
30H: [7..0] 31H: [15..8]	[Vertical_1 position for the ALC weight area] Initial data: 32, data range: 0 to 493 Sets the vertical 1 position for the ALC weight area.	<table border="1"> <tr><td>1</td><td>2</td><td>3</td></tr> <tr><td>4</td><td>5</td><td>6</td></tr> <tr><td>7</td><td>8</td><td>9</td></tr> </table>	1	2	3	4	5	6	7	8	9
1	2	3									
4	5	6									
7	8	9									
32H: [7..0] 33H: [15..8]	[Vertical_2 position for the ALC weight area] Initial data: 169, data range: 0 to 493 Sets the vertical 2 position for the ALC weight area.	<table border="1"> <tr><td>1</td><td>2</td><td>3</td></tr> <tr><td>4</td><td>5</td><td>6</td></tr> <tr><td>7</td><td>8</td><td>9</td></tr> </table>	1	2	3	4	5	6	7	8	9
1	2	3									
4	5	6									
7	8	9									
34H: [7..0] 35H: [15..8]	[Vertical_3 position for the ALC weight area] Initial data: 298, data range: 0 to 493 Sets the vertical 3 position for the ALC weight area.	<table border="1"> <tr><td>1</td><td>2</td><td>3</td></tr> <tr><td>4</td><td>5</td><td>6</td></tr> <tr><td>7</td><td>8</td><td>9</td></tr> </table>	1	2	3	4	5	6	7	8	9
1	2	3									
4	5	6									
7	8	9									
36H: [7..0] 37H: [15..8]	[Vertical_4 position for the ALC weight area] Initial data: 462, data range: 0 to 493 Sets the vertical 4 position for the ALC weight area.	<table border="1"> <tr><td>1</td><td>2</td><td>3</td></tr> <tr><td>4</td><td>5</td><td>6</td></tr> <tr><td>7</td><td>8</td><td>9</td></tr> </table>	1	2	3	4	5	6	7	8	9
1	2	3									
4	5	6									
7	8	9									
38H: [7..0] 39H: [15..8]	[Horizontal_1 position for the ALC weight area] Initial data: 36, data range: 0 to 647 Sets the horizontal 1 position for the ALC weight area.	<table border="1"> <tr><td>1</td><td>2</td><td>3</td></tr> <tr><td>4</td><td>5</td><td>6</td></tr> <tr><td>7</td><td>8</td><td>9</td></tr> </table>	1	2	3	4	5	6	7	8	9
1	2	3									
4	5	6									
7	8	9									
3AH: [7..0] 3BH: [15..8]	[Horizontal_2 position for the ALC weight area] Initial data: 252, data range: 0 to 647 Sets the horizontal 2 position for the ALC weight area.	<table border="1"> <tr><td>1</td><td>2</td><td>3</td></tr> <tr><td>4</td><td>5</td><td>6</td></tr> <tr><td>7</td><td>8</td><td>9</td></tr> </table>	1	2	3	4	5	6	7	8	9
1	2	3									
4	5	6									
7	8	9									
3CH: [7..0] 3DH: [15..8]	[Vertical_3 position for the ALC weight area] Initial data: 396, data range: 0 to 647 Sets the horizontal 3 position for the ALC weight area.	<table border="1"> <tr><td>1</td><td>2</td><td>3</td></tr> <tr><td>4</td><td>5</td><td>6</td></tr> <tr><td>7</td><td>8</td><td>9</td></tr> </table>	1	2	3	4	5	6	7	8	9
1	2	3									
4	5	6									
7	8	9									
3EH: [7..0] 3FH: [15..8]	[Vertical_4 position for the ALC weight area] Initial data: 612, data range: 0 to 647 Sets the horizontal 4 position for the ALC weight area.	<table border="1"> <tr><td>1</td><td>2</td><td>3</td></tr> <tr><td>4</td><td>5</td><td>6</td></tr> <tr><td>7</td><td>8</td><td>9</td></tr> </table>	1	2	3	4	5	6	7	8	9
1	2	3									
4	5	6									
7	8	9									

--	--

Command No.	Command Description								
50H: [7..0] 51H: [15..8]	[Y_offset for AOI] Initial data: 0, data range: $2 \leq \text{"Y\_offset + Height"} \leq 494$ Sets the Y_offset (the vertical start position of the image for the AOI)								
52H: [7..0] 53H: [15..8]	[Height for AOI] Initial data: 494, data range: $2 \leq \text{"Y\_offset + Height"} \leq 494$ Sets the height (the vertical size of the image for the AOI)								
54H: [7..0] 55H: [15..8]	[X_offset for AOI] Initial data: 0, data range: $8 \leq \text{"Y\_offset + Height"} \leq 648$ Sets the X_offset (the horizontal start position of the image for the AOI)								
56H: [7..0] 57H: [15..8]	[Width for AOI] Initial data: 648, data range: $8 \leq \text{"Y\_offset + Height"} \leq 648$ Sets the width (the horizontal size of the image for the AOI)								
60H: [7..0]	[Camera mode 1] Initial data: 00H Sets the white balance area ON/OFF and the gamma table ON/OFF. D[7..0] <table border="1" style="width: 100%; text-align: center;"> <tr> <td>D7</td><td>D6</td><td>D5</td><td>D4</td><td>D3</td><td>D2</td><td>D1</td><td>D0</td> </tr> </table> <p>D7 to D5: No function <span style="float: right;"><u>Always set at "000"</u></span></p> <p>D4: White balance area ON/OFF <span style="float: right;"><u>0: OFF (Full screen)</u>      1: ON (setup area)</span></p> <p>D3 to D1: No function <span style="float: right;"><u>Always set as "000"</u></span></p> <p>D0: Gamma table ON/OFF <span style="float: right;"><u>0: OFF (Gamma=1.0)</u>      1: ON</span></p>	D7	D6	D5	D4	D3	D2	D1	D0
D7	D6	D5	D4	D3	D2	D1	D0		
92H: [7..0]	[Iris lens manual adjustment] Initial data: 01H Sets the iris lens manual adjustment operation. D[7..0] <table border="1" style="width: 100%; text-align: center;"> <tr> <td>D7</td><td>D6</td><td>D5</td><td>D4</td><td>D3</td><td>D2</td><td>D1</td><td>D0</td> </tr> </table> <p>D7 to D2: No function <span style="float: right;">Always set as "000000"</span></p> <p>D1 to D0: Manual adjustment operation <span style="float: right;">00: Hold 01: Open 10: Close 11: No Function (Prohibited setting. Do not set this value)</span></p>	D7	D6	D5	D4	D3	D2	D1	D0
D7	D6	D5	D4	D3	D2	D1	D0		

## 4.5 GenICam Command / Camera Command Reference Table

GenICam command	Camera command		
	Device	Command	Function
Width	100000	56-57H	Width for AOI (pixel)
Height	100000	52-53H	Height for AOI (pixel)
PixelFormat	000000	12H.6-7	Video out (bit)
OffsetX	100000	54-55H	X offset for AOI (pixel)
OffsetY	100000	50-51H	Y offset for AOI (pixel)
BinningVertical	000000	10H.4	Binning
ExposureMode	000000	10H.5	Trigger mode
ExposureTimeRaw	000000	20-22H	Exposure time of the electronic shutter
ExposureAuto	100000	20H.2	Shutter mode
AcquisitionFrameRate	000000	58-5CH	Frame rate
TriggerDelay	000000	50-53H	The delay time for the trigger signal
TriggerActivation	000000	10H.6	Trigger polarity
TriggerSource	000000	12H.5	Trigger signal type
TriggerSoftware	000000	16H.0	Generate command software trigger
TriggerSoftwareSource	000000	16H.6-7	Software trigger source selection
TriggerMode	000000	11H.3	Function mode
LineSource0	000000	F0H.0-3	Output signal for 2 pin of the power-I/O connector
LineSource1	000000	F0H.4-7	Output signal for 3 pin of the power-I/O connector
UserOutputValue0	000000	F1H.3	UserOutput signal for 2 pin of the power-I/O connector
UserOutputValue1	000000	F1H.4	UserOutput signal for 3 pin of the power-I/O connector
LineInverter0	000000	5DH.0	Output signal polarity for 2 pin of the power-I/O connector
LineInverter1	000000	5DH.1	Output signal polarity for 3 pin of the power-I/O connector
StrobeSignalOnTime	000000	90-93H	Strobe signal active time
StrobeSignalDelay	000000	54-57H	The delay time for the strobe signal (us)

GenICam command	Camera command		
	Device	Command	Function
GainAuto	100000	20H.3	AGC
GainRaw	000000	30H	CDS gain
SmearHalfReduction	000000	11H.4	Smear half reduction
GammaMode	100000	60H.0	Gamma table ON/OFF
ReloadGammaData	100000	60H.7	Gamma table ON/OFF
LensManualAdjustment	100000	92H.0-1	Iris lens manual adjustment operation
LensIrisAdjustment	100000	90H	Iris lens adjustment
PriorityMode	100000	20H.0	ALC control method priority
ALCIrisLens	100000	20H.1	Iris lens control method
Min_ShutterTime	100000	26-28H	The lower limit of the electronic shutter for auto shutter (us)
Max_ShutterTime	100000	23-25H	The upper limit of the electronic shutter for auto shutter (us)
AGCRange	100000	21H	AGC maximum limit
TargetBrightness	100000	2EH	Target brightness for ALC
ALC_Peak_Average	100000	2FH	ALC peak-average
DigitalGain	000000	31H	The digital gain
ALCWeight1	100000	29H.0-3	Weight1 for ALC
ALCWeight2	100000	29H.4-7	Weight2 for ALC
ALCWeight3	100000	2AH.0-3	Weight3 for ALC
ALCWeight4	100000	2AH.4-7	Weight4 for ALC
ALCWeight5	100000	2BH.0-3	Weight5 for ALC
ALCWeight6	100000	2BH.4-7	Weight6 for ALC
ALCWeight7	100000	2CH.0-3	Weight7 for ALC
ALCWeight8	100000	2CH.4-7	Weight8 for ALC
ALCWeight9	100000	2DH.0-3	Weight9 for ALC
ALCWindowV1	100000	30-31H	Vertical1 position for the ALC weight area (pixel)
ALCWindowV2	100000	32-33H	Vertical2 position for the ALC weight area (pixel)
ALCWindowV3	100000	34-35H	Vertical3 position for the ALC weight area (pixel)
ALCWindowV4	100000	36-37H	Vertical4 position for the ALC weight area (pixel)
ALCWindowH1	100000	38-39H	Horizontal1 position for the ALC weight area (pixel)
ALCWindowH2	100000	3A-3BH	Horizontal2 position for the ALC weight area (pixel)
ALCWindowH3	100000	3C-3DH	Horizontal3 position for the ALC weight area (pixel)
ALCWindowH4	100000	3E-3FH	Horizontal4 position for the ALC weight area (pixel)

Caution:

Width, Height and PixelFormat all affect the image data size.

Please use command name defined by GenICam when changing these values, as exemplified in the following sample code.

In the case to change the Width

```
BOOL SetWidth( PvDevice *pDevice, PvInt64 IValue )
{
    PvGenInteger* IGenInteger = dynamic_cast<PvGenInteger*>( pDevice->GetGenParameters()->Get( "Width" ) );
    PvResult IResult = IGenInteger->SetValue(IValue);
    return IResult.IsOK();
}
```

## Revision History

Rev	Date	Changes	Note
1.00	2012/06/19	<ul style="list-style-type: none"><li>● Initial Release</li></ul>	
1.01	2012/07/06	<ul style="list-style-type: none"><li>● Updated Document title Camera Command List (Device Code: 000000) 10-13H, 3E-3F, 58-5CH, Camera Command List (Device Code: 100000) 20H, 21H, 22H, 23-28H Deleted 90H Deleted description about white balance GenlCam command Deleted white balance description</li></ul>	

**RICOH COMPANY, LTD.**

URL [http://www.ricoh.com/fa\\_security/](http://www.ricoh.com/fa_security/)